

313

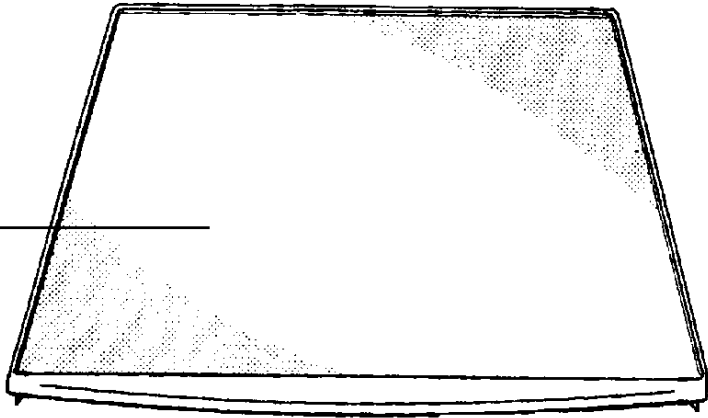

307

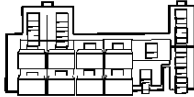
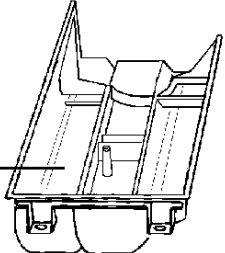

148

525

563

535

510

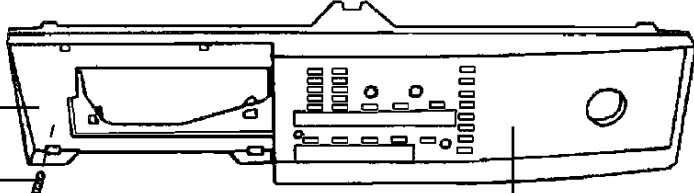

531



510A



510C

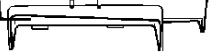

510E

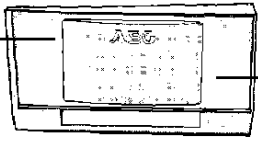

500

510B

531Z



323

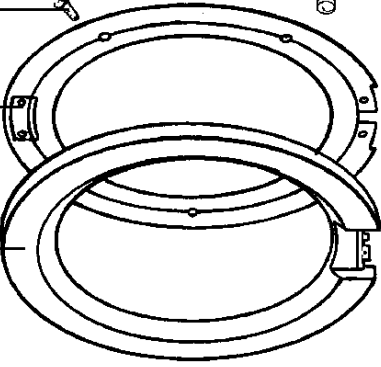

323A



530A



260A

260B

563A

260C

521

507



