

313

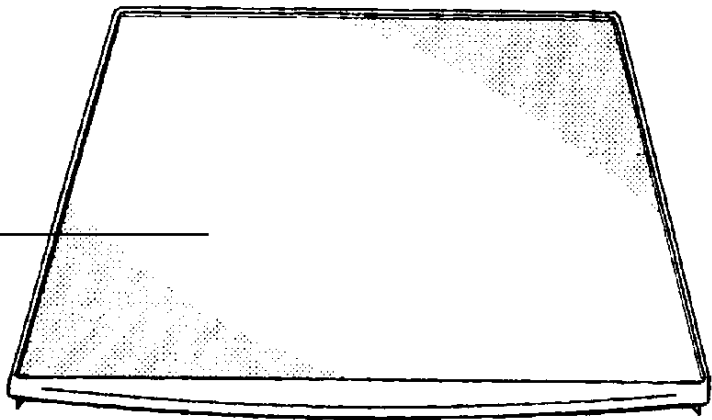

307

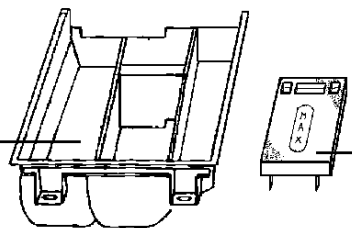

148

510

531

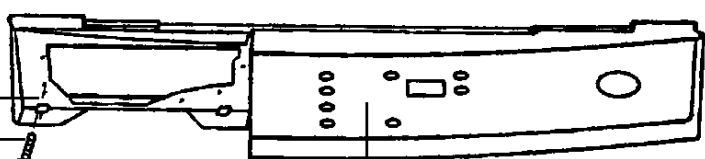

510A

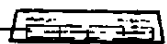

510D

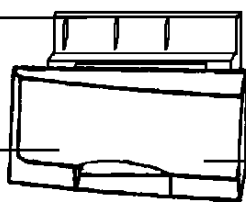

510E



563



500

260



510C

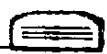

531Z



530A

260A

323

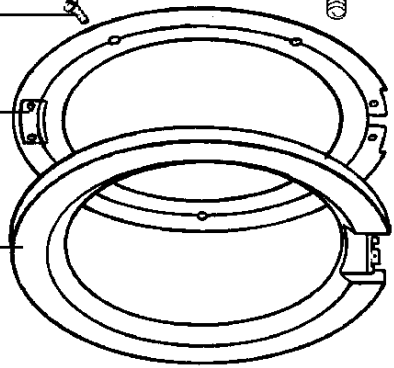

323A



260B

563A

260C



521

507

