

103
4000

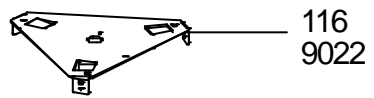

116
9022

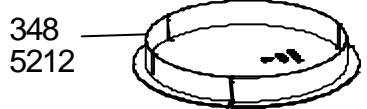

348
5212



157
9632

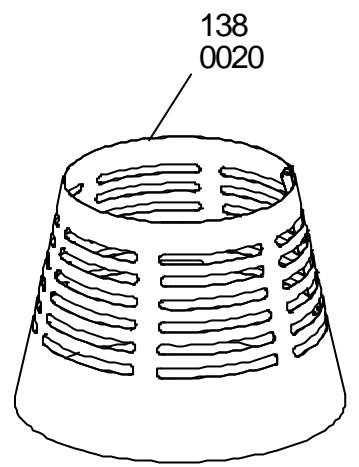

138
0020

24
7621

*

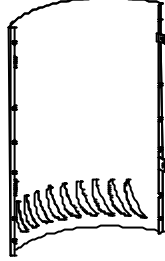

32
6520

31
6510

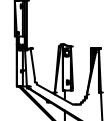
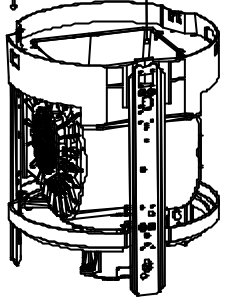
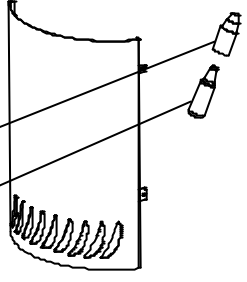

563
0013

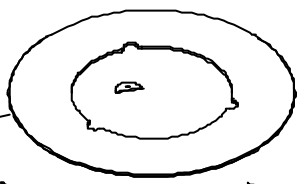

486
0022



59
2451

122
3010

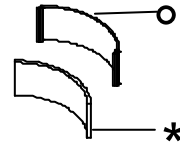

49
5210

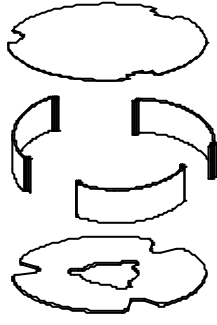

23
7620

o



19
4200



20
4210

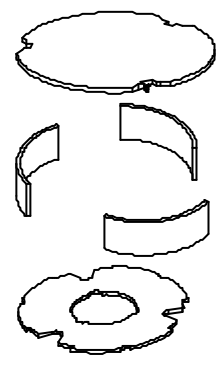

120
7650

*



*



o



156
9631



105
6523



32
6520



31
6510



422
9100

161
0054