

VUE A

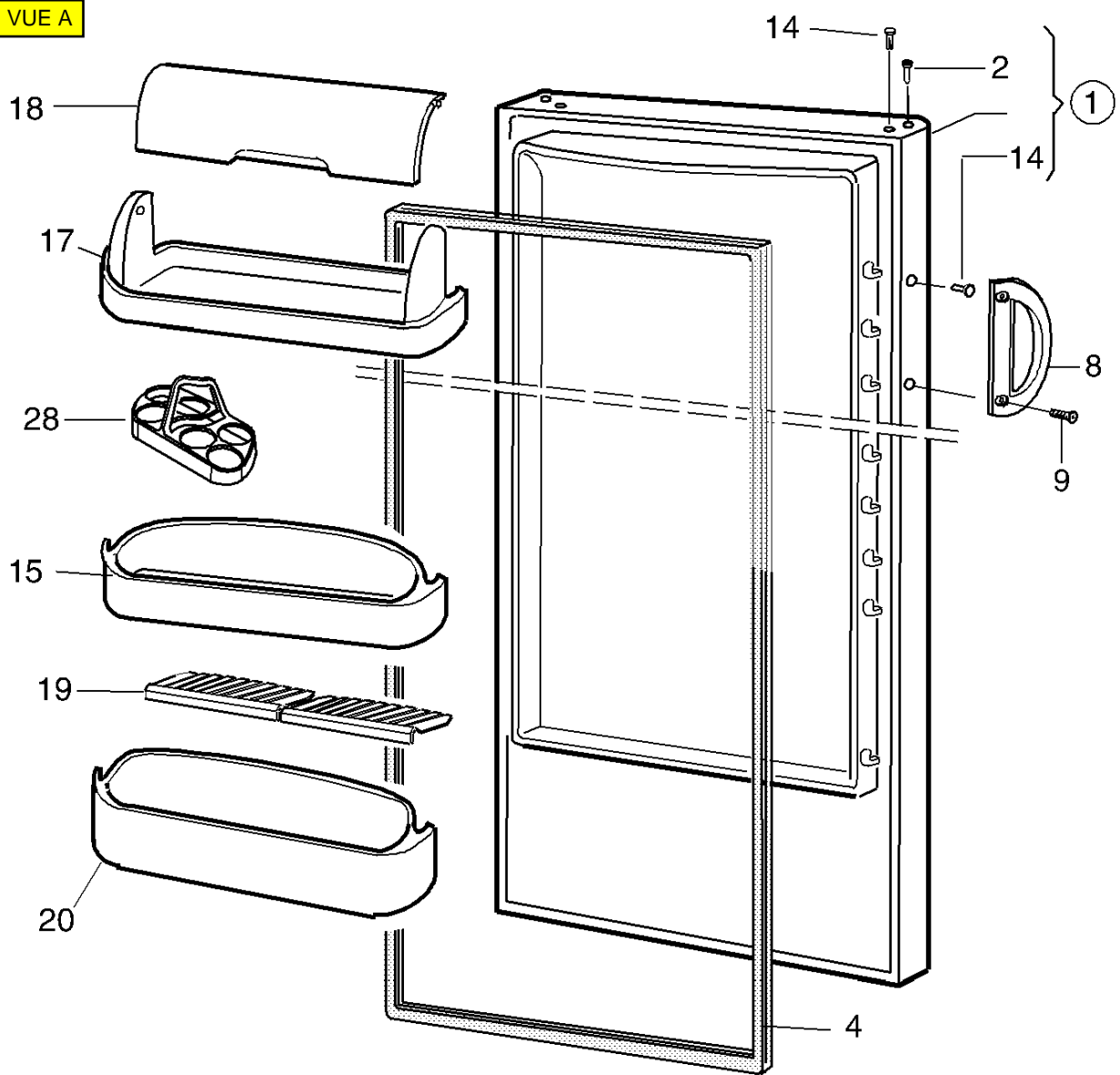

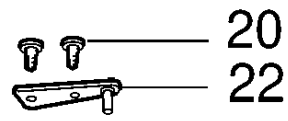

PLAQUE
SIGNALETIQUE

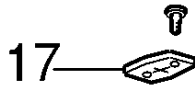
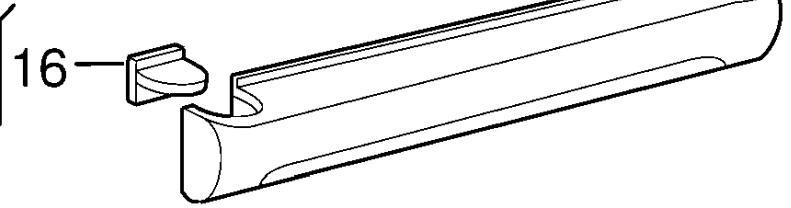
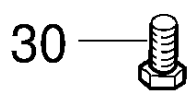
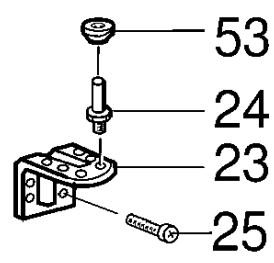
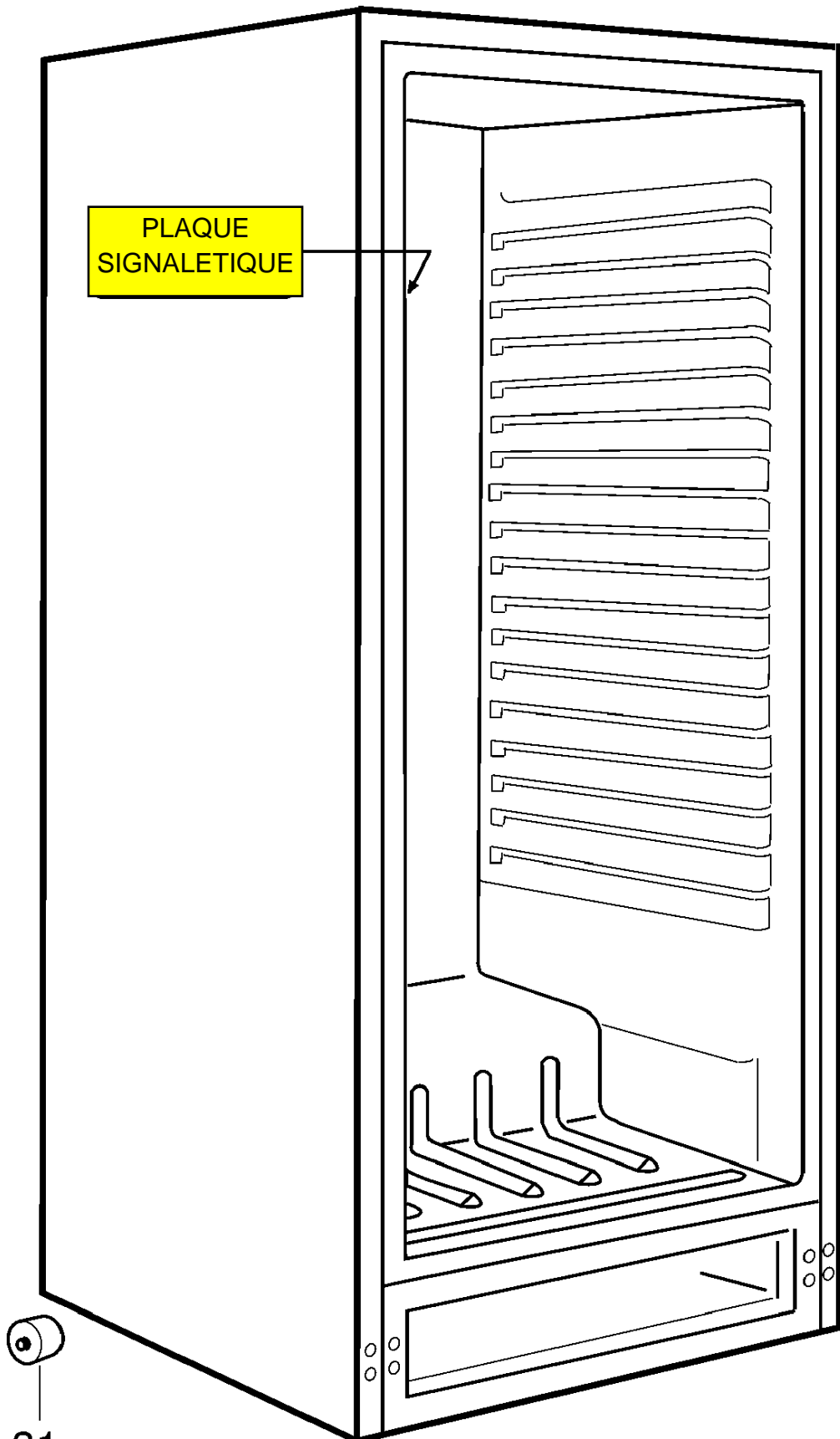

27

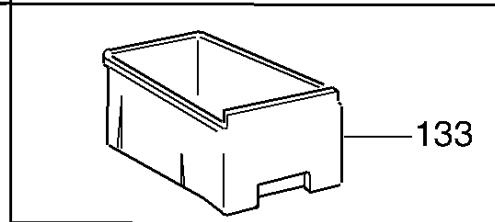
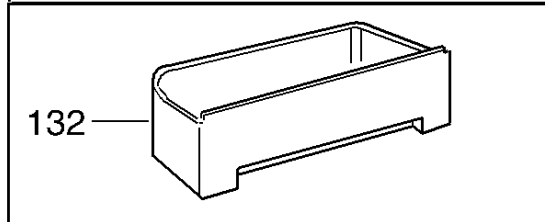
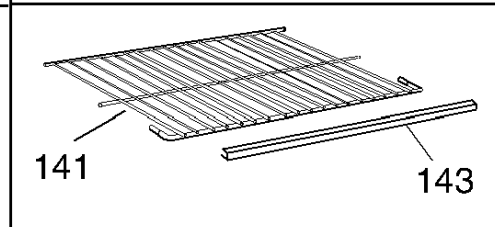
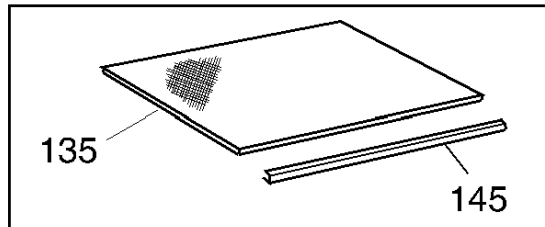
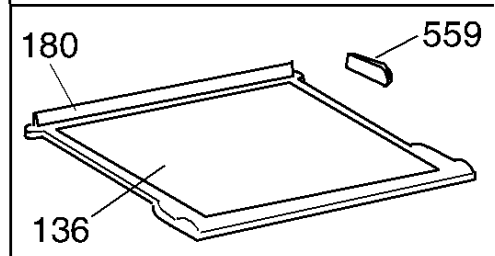
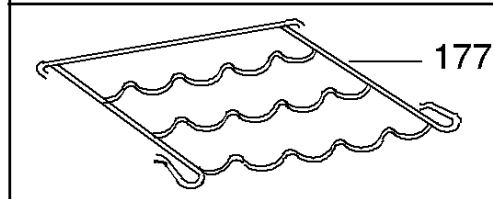
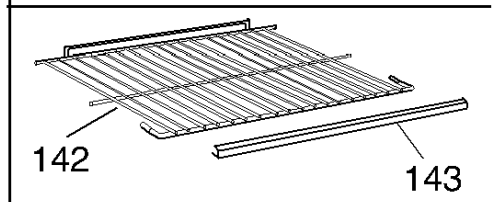
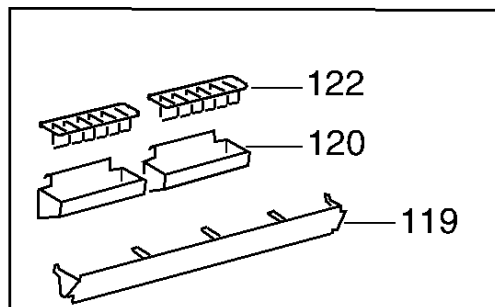
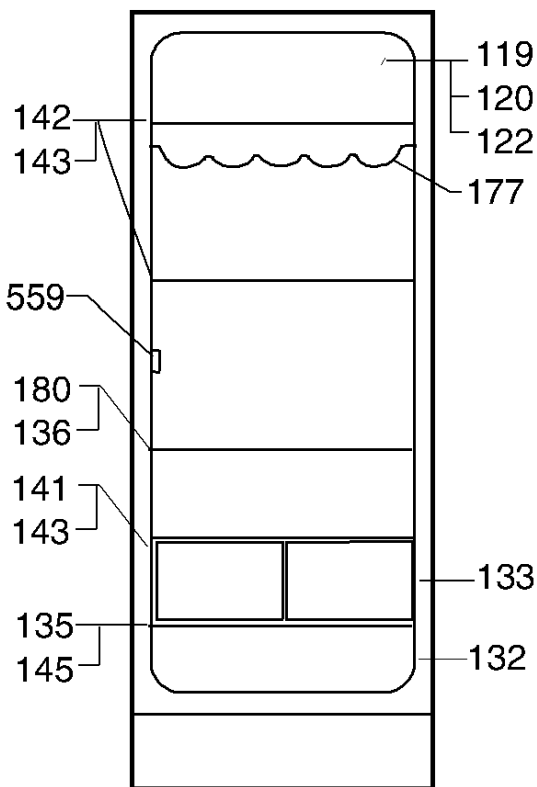

VUE D

