

28

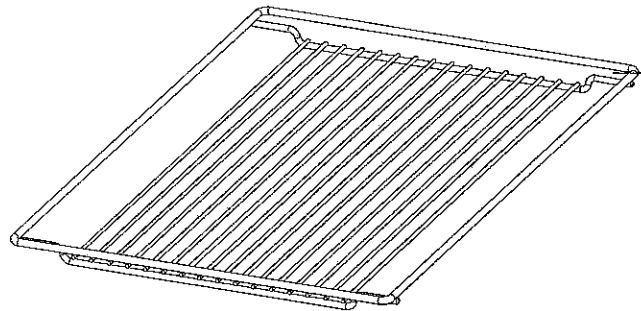

27

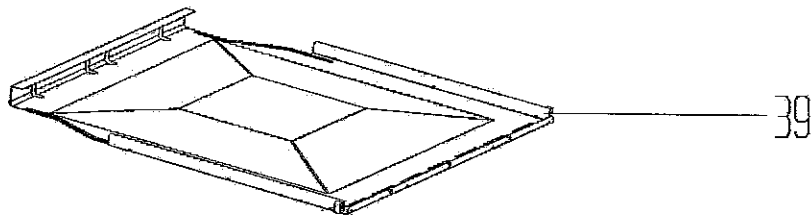
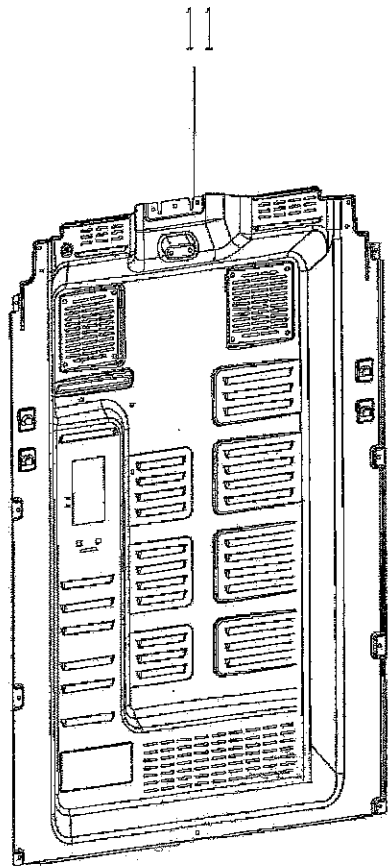
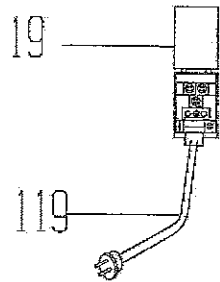

417

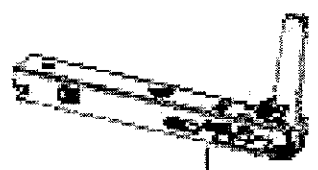
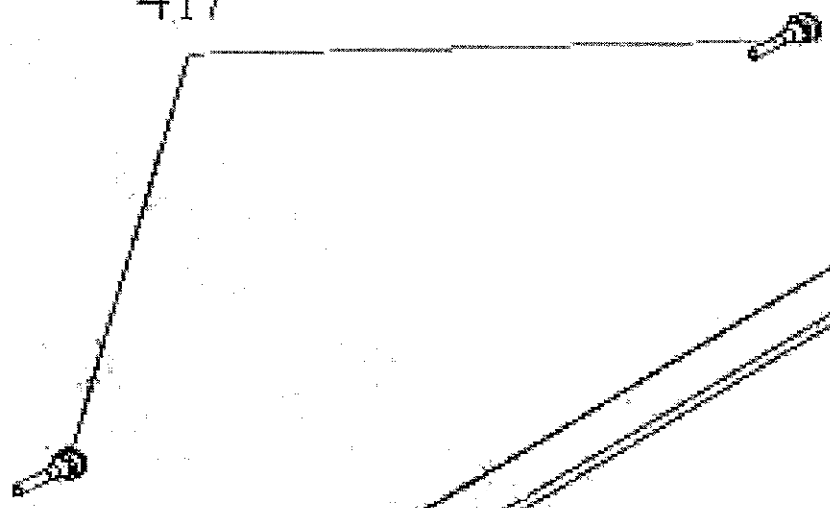

983



982

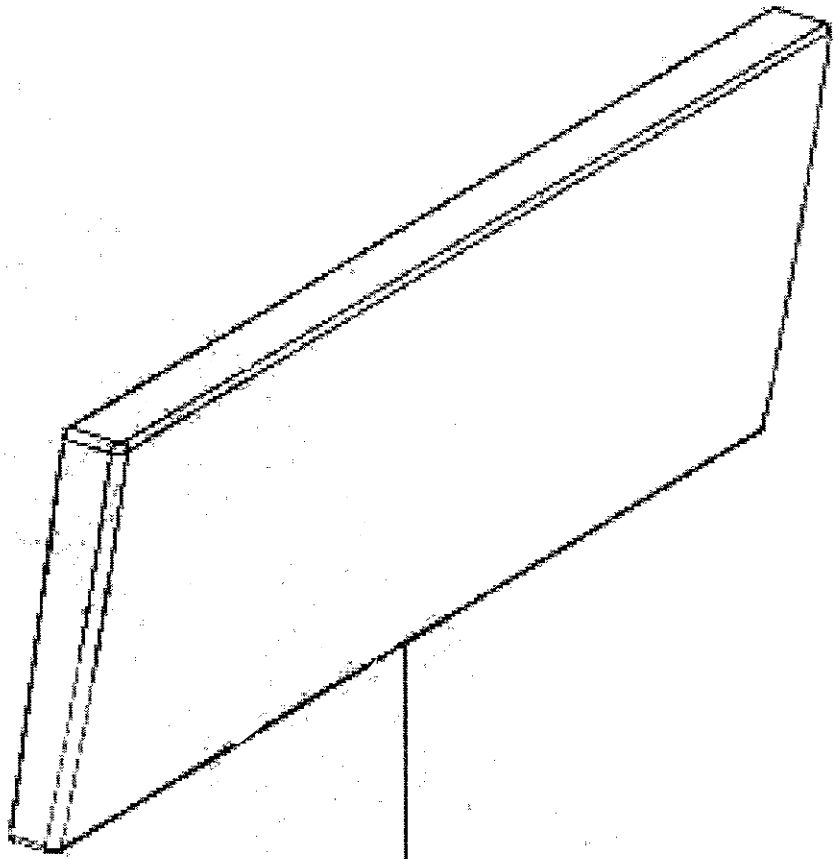

48