

28

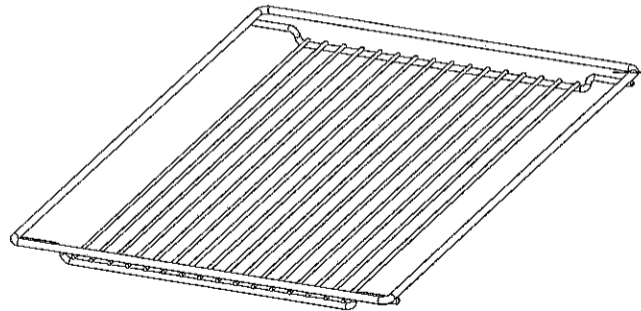

27

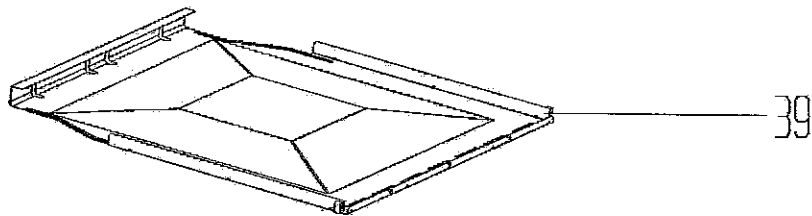
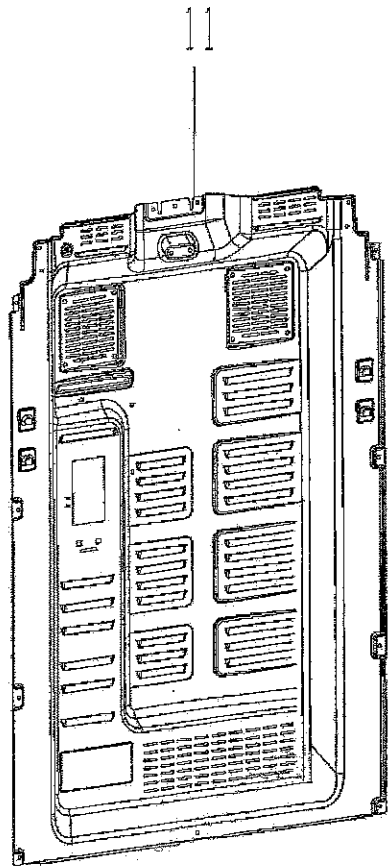
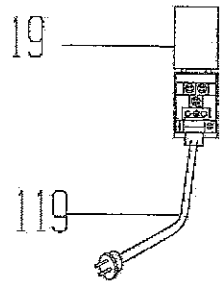

417

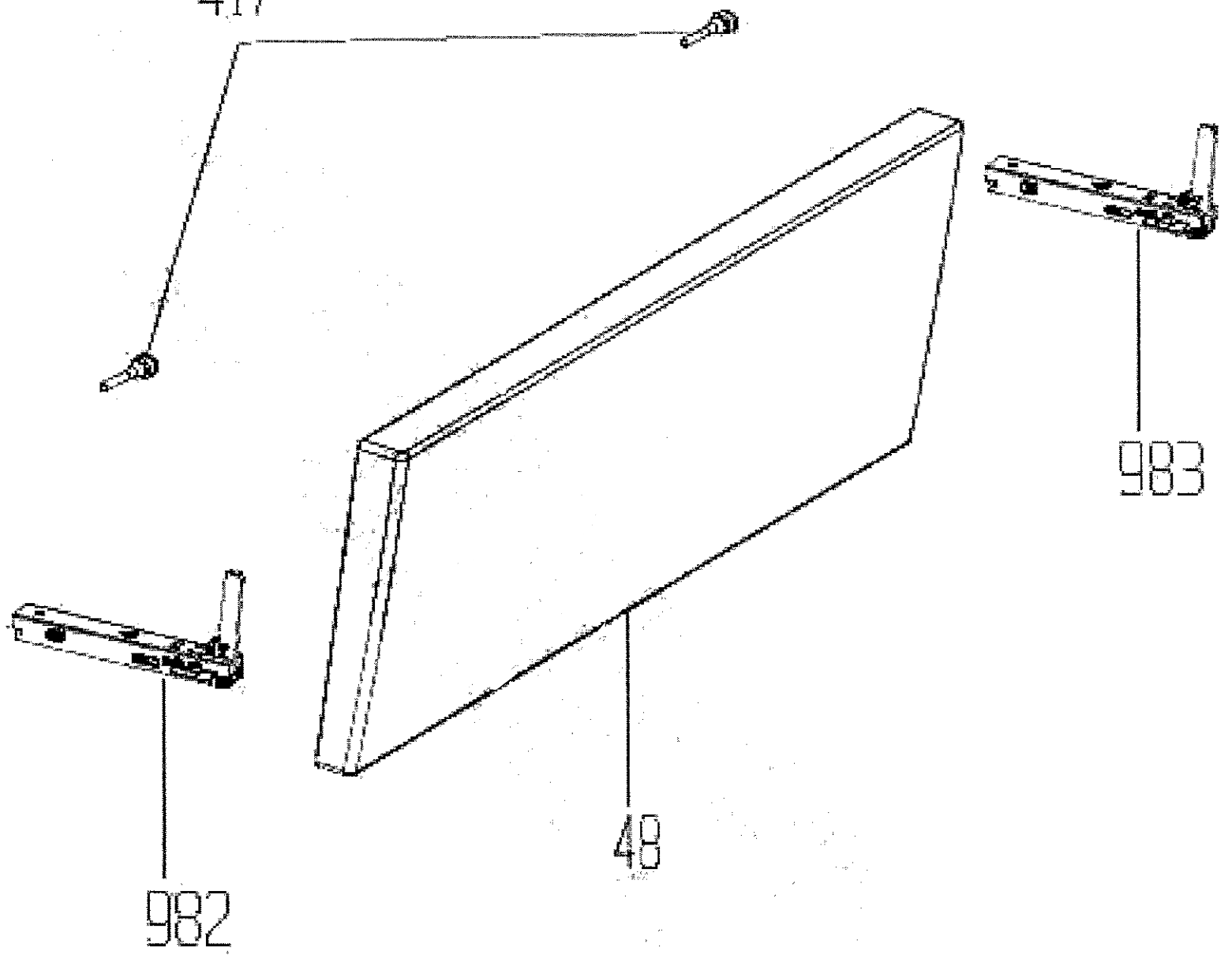

983

48

982

