

14

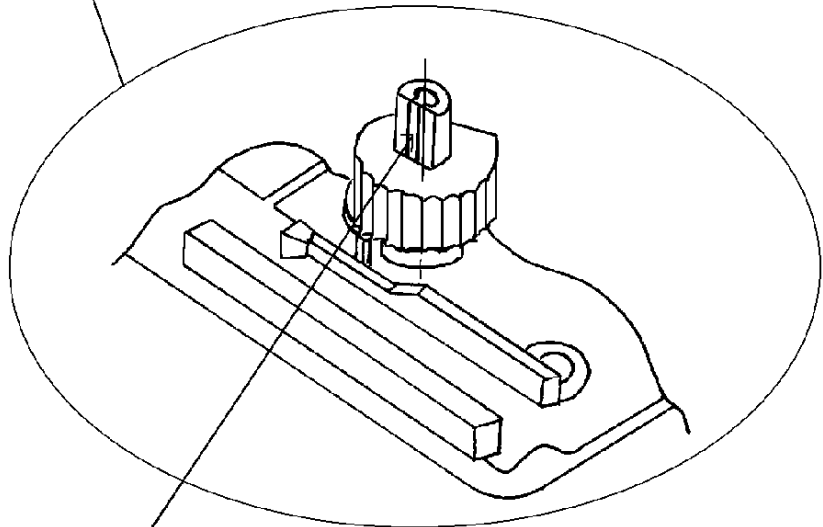

VIS SOUS TENSION
CURRENT-CARRYING SCREW
SCHRAUBE UNTER SPANNUNG

