

106

109

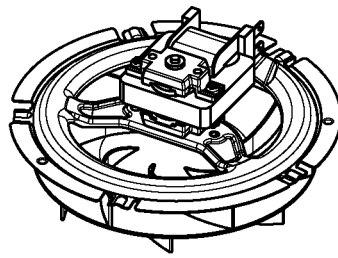

510V



518V



522

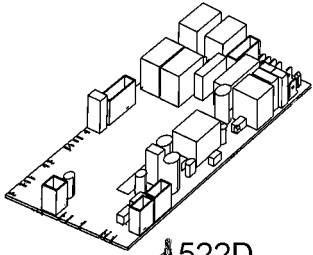

516A

522D

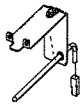

518



502U



504U



506U

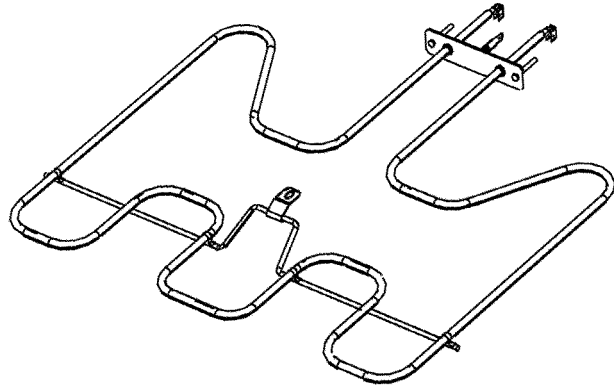

500U

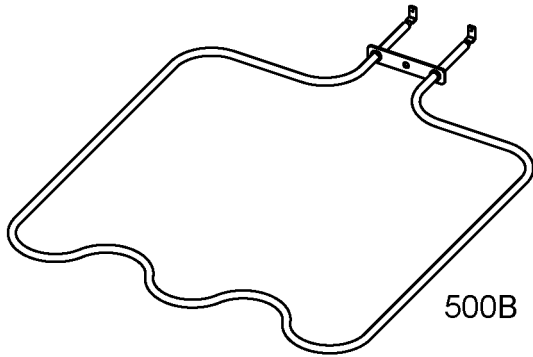

500B

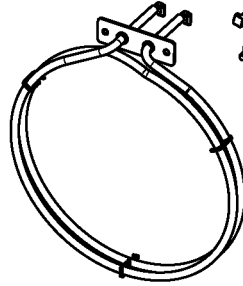

500C



510C

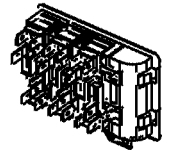

530

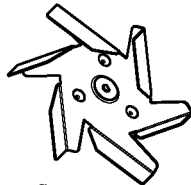

512

513

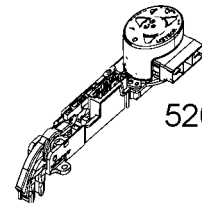

520