

26 6722

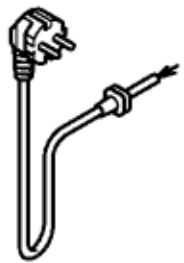

17 1254

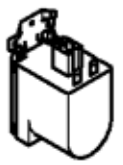

49 3685

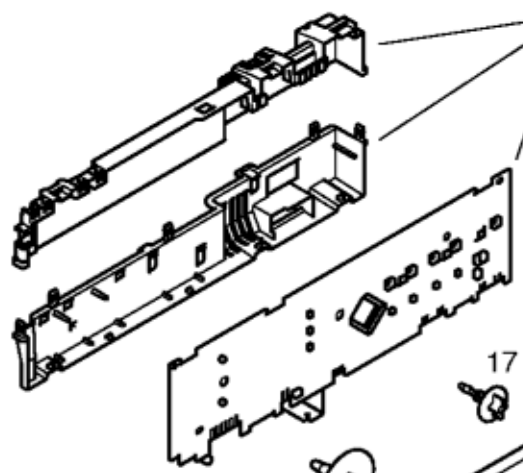

17 2698

17 2697

1)

17 3541 1)

17 2706 1)

17 2705 1)

26 6749 1)

18 3594



18 3595



41 8251



18 3599

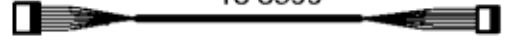

18 3602

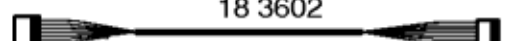

41 8253

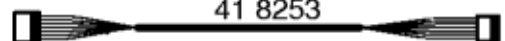

41 8255

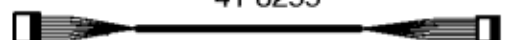

41 8254

