

WARMER DRAWER ASSEMBLY

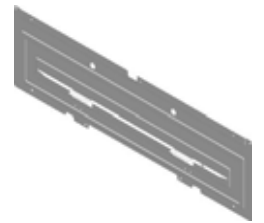

50x60



60x60

WARMER DRAWER
INNER COVER

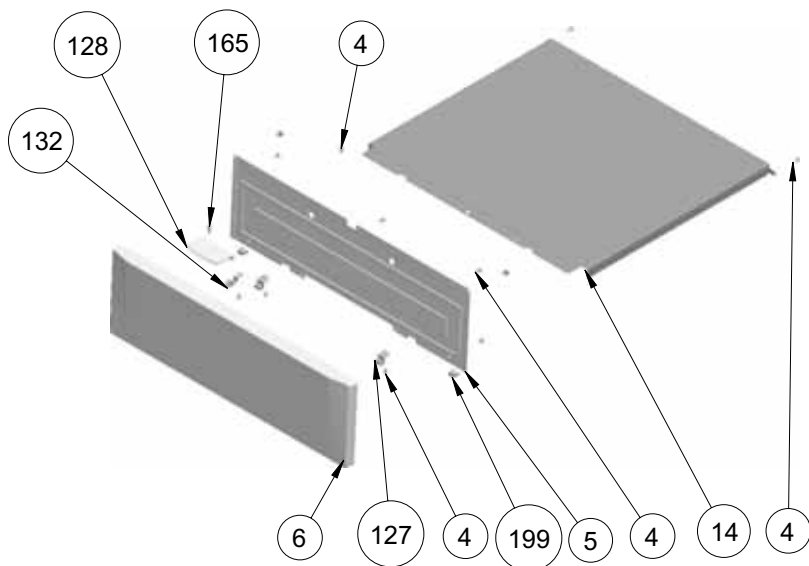

FLAP DRAWER ASSEMBLY
(OPTIONAL)



50x60



60x60

FLAP DRAWER
INNER COVER

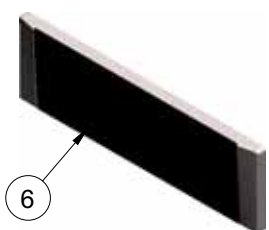

3D GLASS DRAWER PANEL
(OPTIONAL)

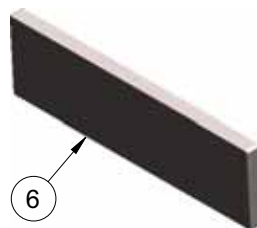

FLAT DRAWER PANEL
(OPTIONAL)

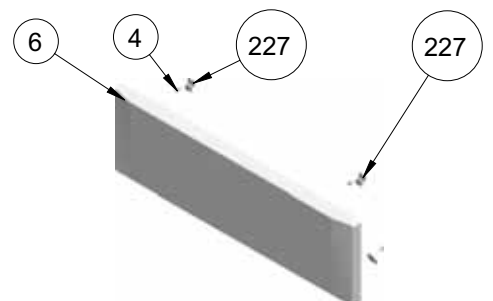

FIXED DRAWER ASSEMBLY
(OPTIONAL)

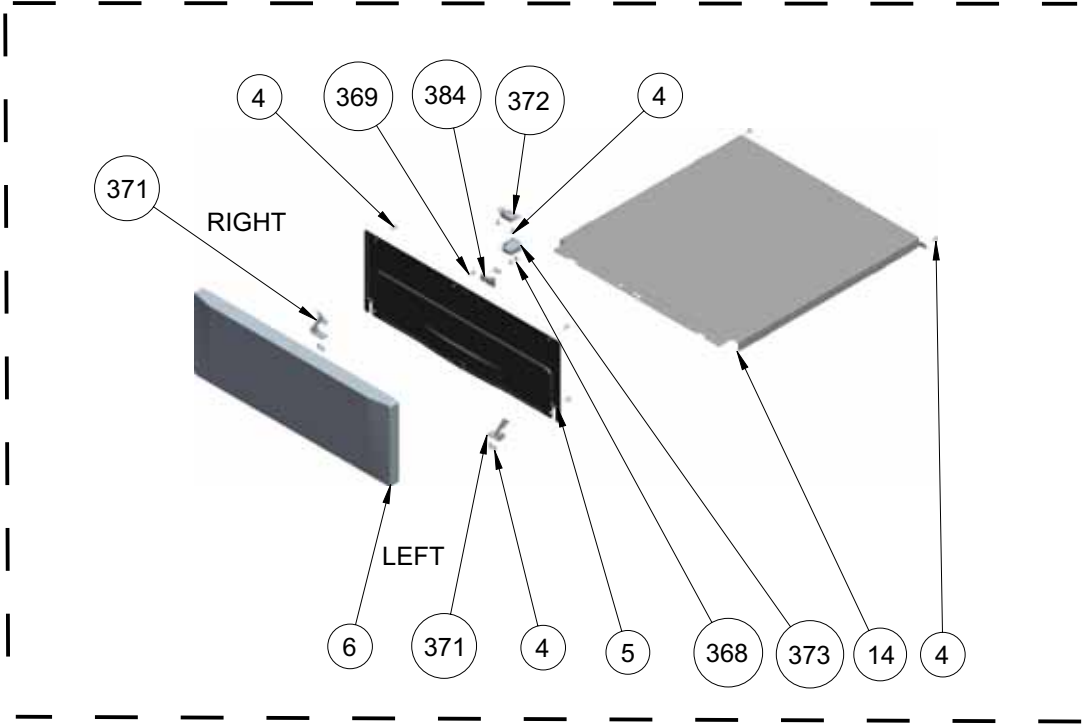

PUSH-PULL FLAP DRAWER ASSEMBLY
(OPTIONAL)

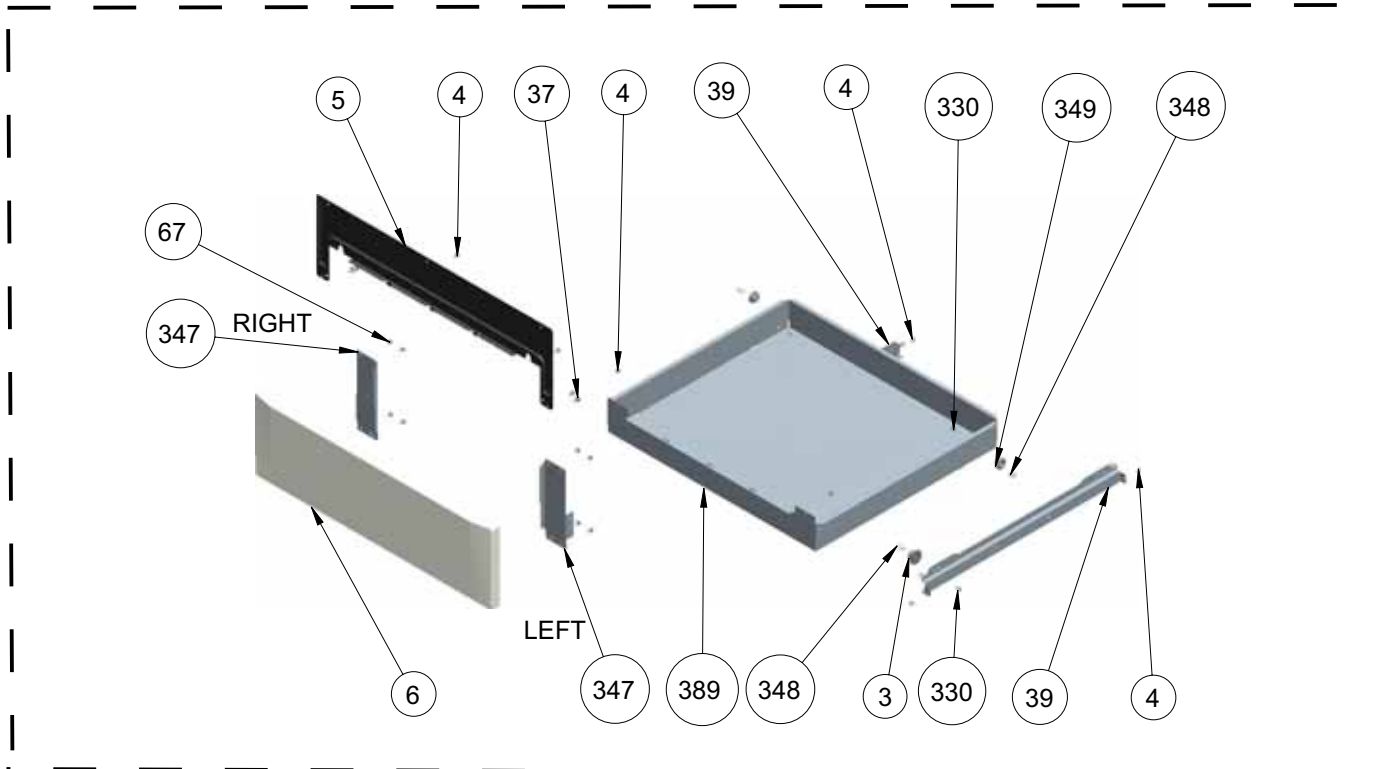

4WG DRAWER ASSEMBLY
(OPTIONAL)

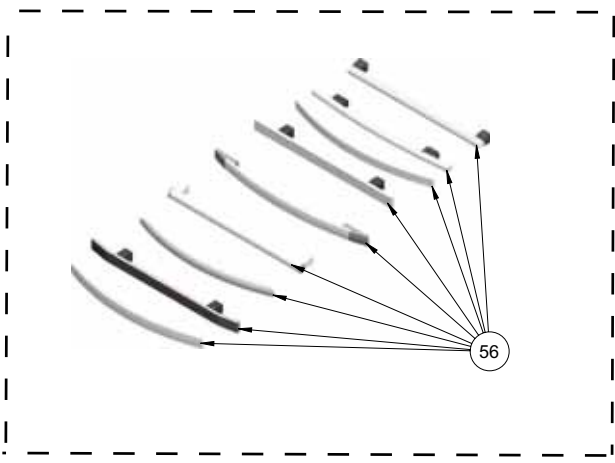

OVEN DOOR HANDLES (OPTIONAL)

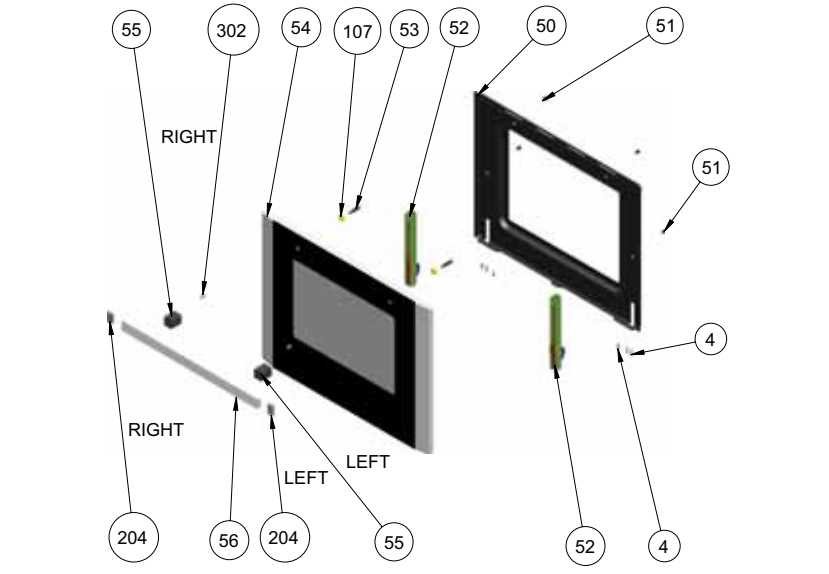

3D OVEN DOOR (POSITION NO 374)

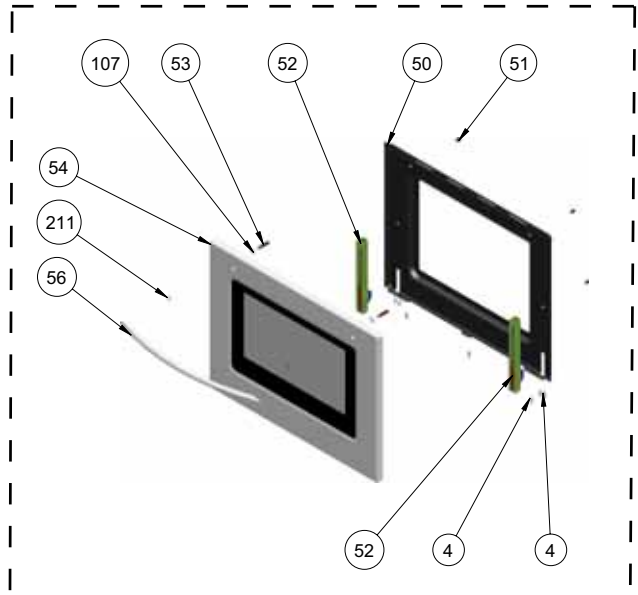

SOLID TYPE (OPTIONAL) (POSITION NO 375)

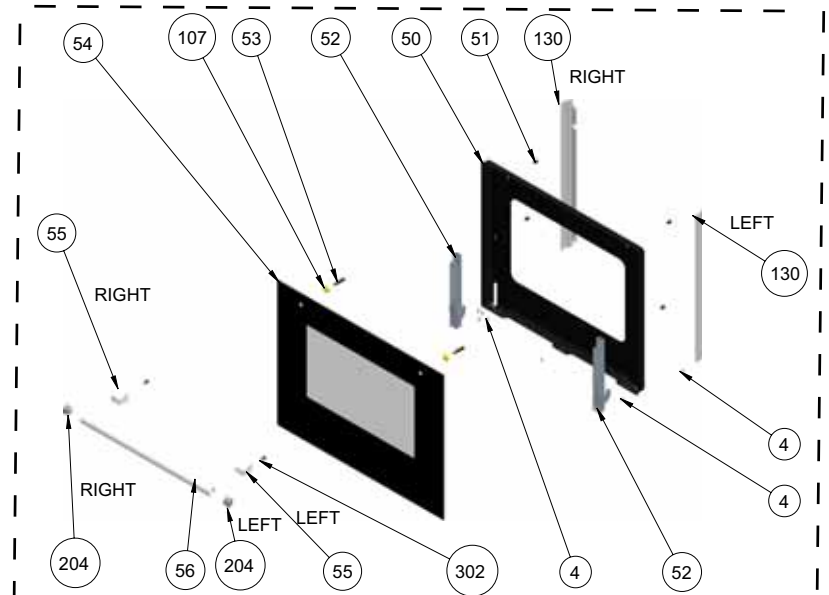

FLAT TYPE OVEN DOOR (OPTIONAL) (POSITION NO 376)

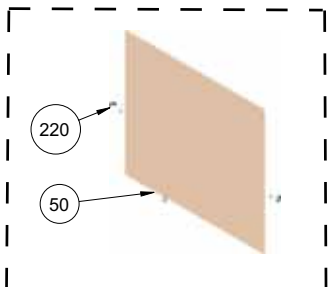

INTERVAL GLASS (OPTIONAL)

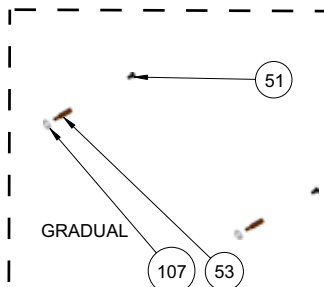

HANDLE ASSEMBLY GROUP (OPTIONAL) (POSITION NO 49)

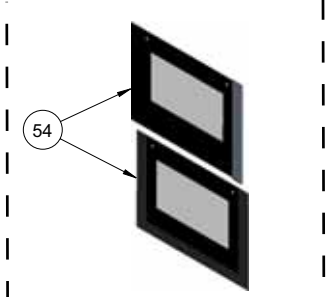

OVEN DOOR OUTER GLASS ASSEMBLY WITH INOX ADD-ON TYPES (OPTIONAL)

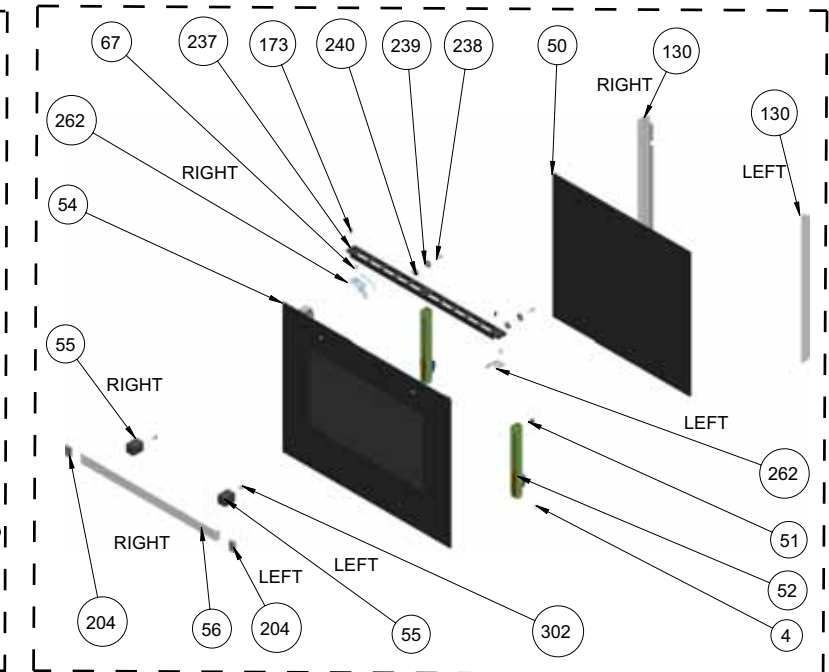
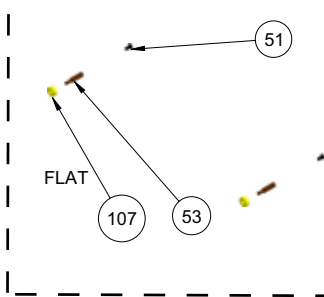

FLAT OVEN DOOR WITH FULL GLASS STRUCTURE (OPTIONAL) (POSITION NO 377)

*Metal frames on outer glass, handle types, handle taps and brackets are optional. Your cooker may be different cosmetically.

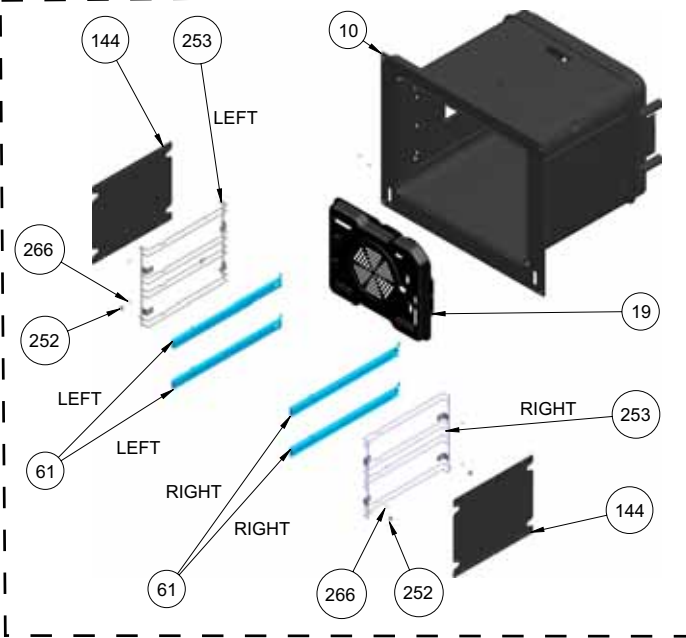

WIRE SHELF CAVITY ASSEMBLY WITH / WITHOUT CATALYTIC PANEL
 OPTIONAL : DOUBLE TELESCOPIC RAILS (R / L)

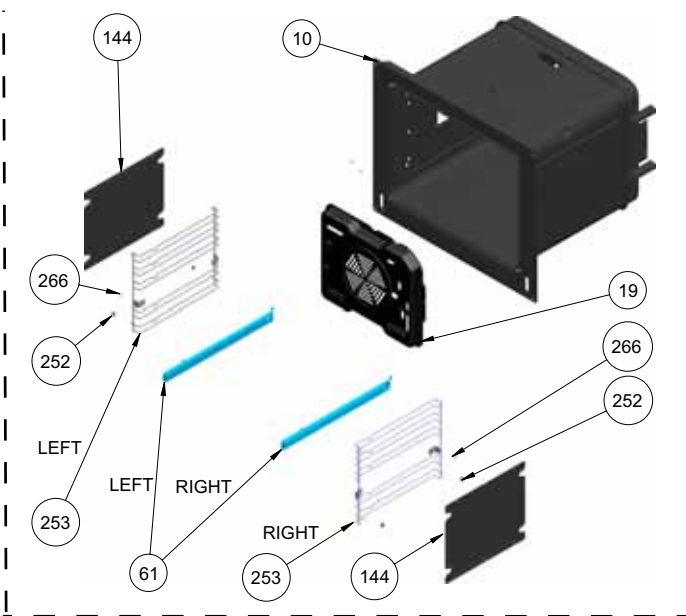
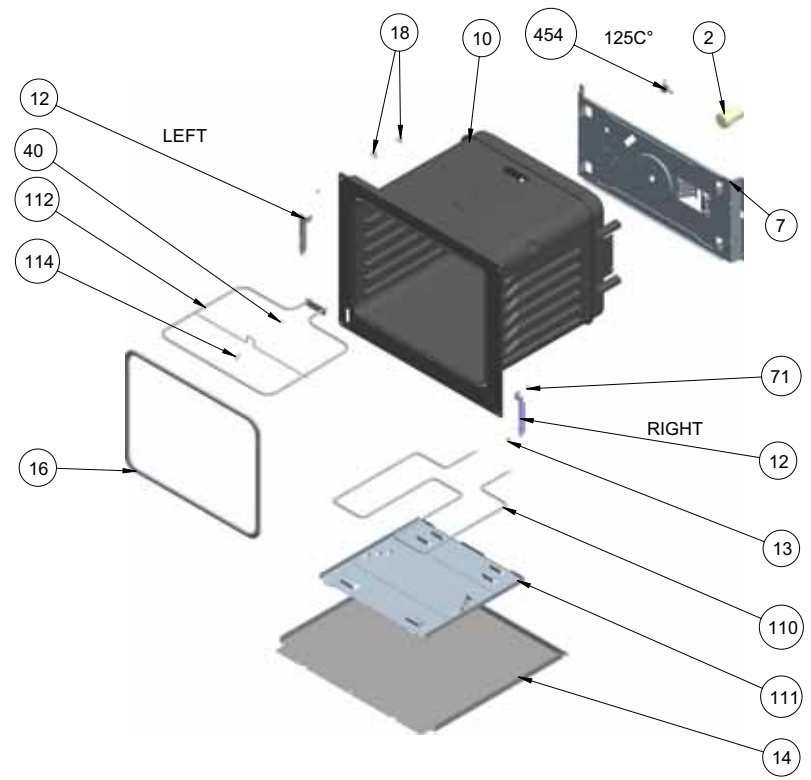

WIRE SHELF CAVITY ASSEMBLY WITH / WITHOUT CATALYTIC PANEL
 OPTIONAL : TELESCOPIC RAIL (R / L)

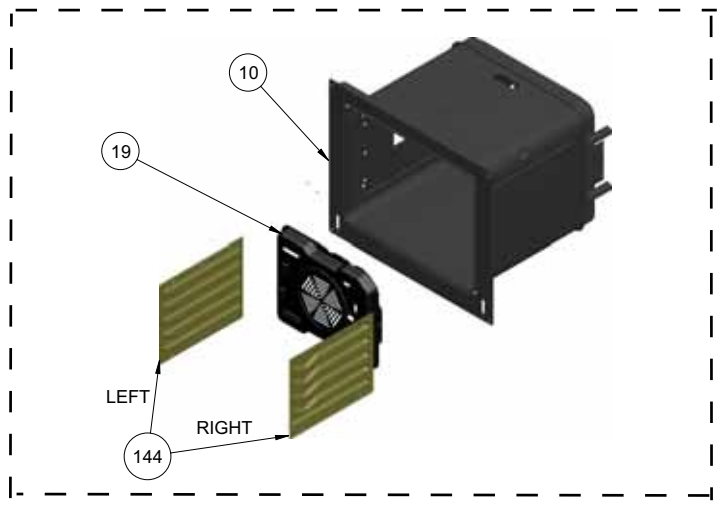

CAVITY ASSEMBLY WITH CATALYTIC SHELF
 (OPTIONAL)

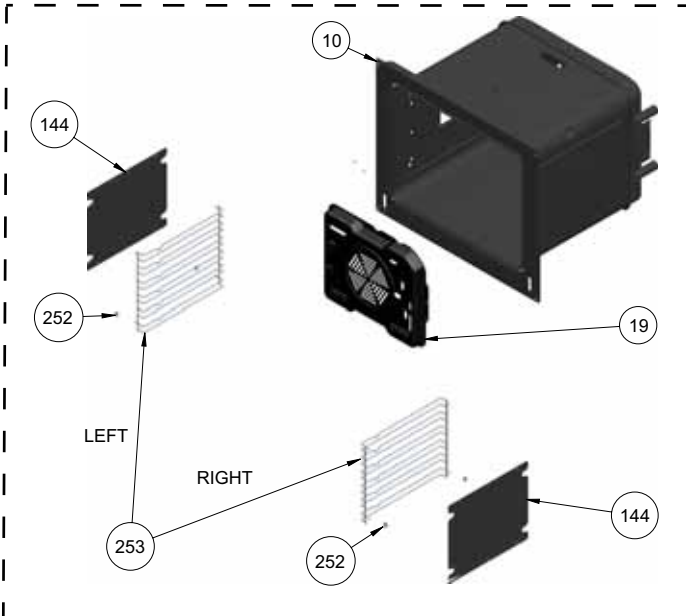

WIRE SHELF CAVITY ASSEMBLY WITH / WITHOUT CATALYTIC PANEL
 (OPTIONAL)

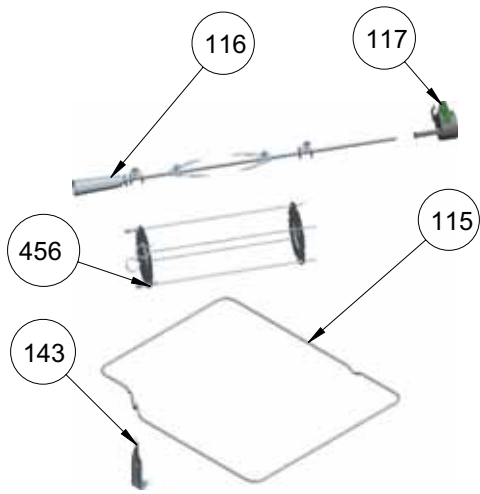

TURNSPIT (OPTIONAL)

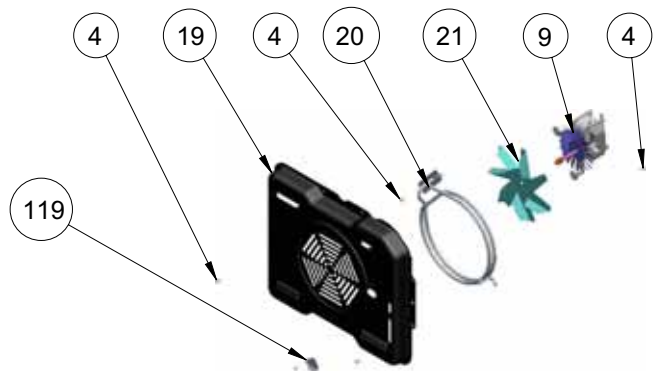

RING HEATING ELEMENT WITH FAN (OPTIONAL)

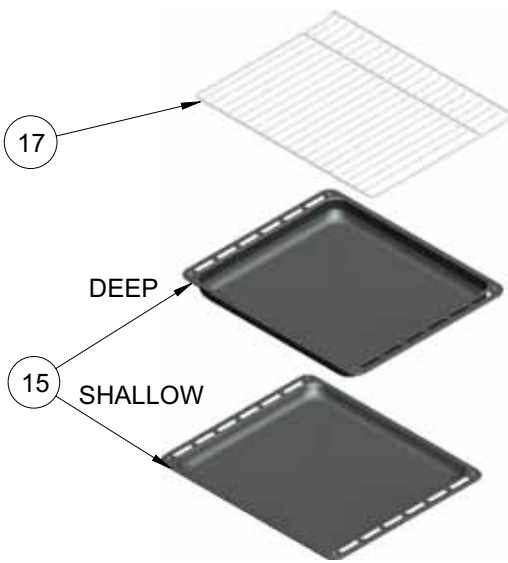

TRAYS & GRID (OPTIONAL)

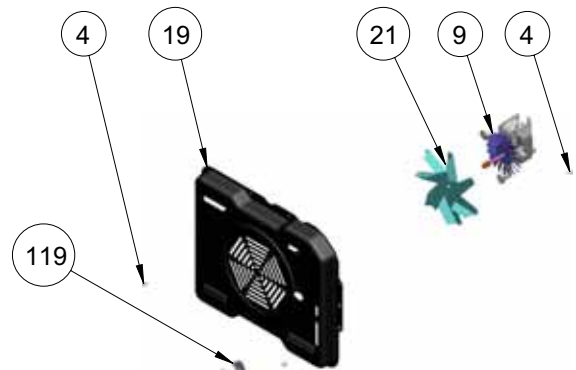

(FAN COVER/ FAN IMPELLER(6 WINGS) / FAN MOTOR) (OPTIONAL)

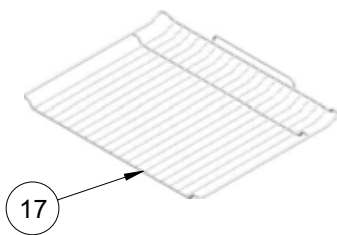

LOCKED

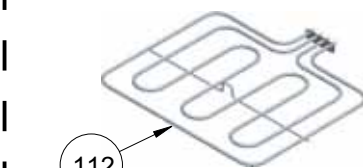

TOP AND GRILL HEATING ELEMENT (OPTIONAL)

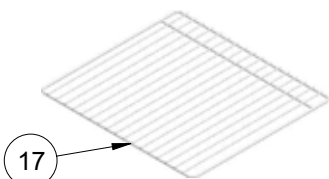

W. TELESCOPIC RAIL
GRID (OPTIONAL)

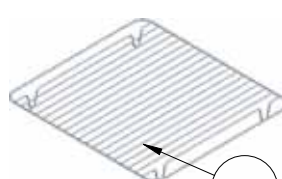

DEEP TRAY GRID (OPTIONAL)

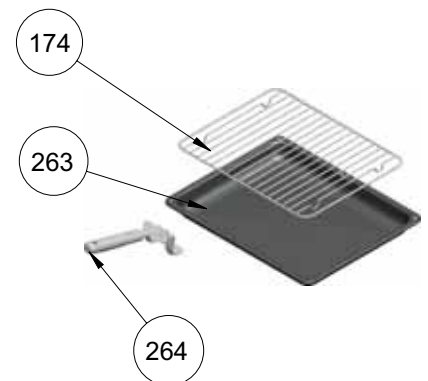

TRAY SET FOR GRID (POSITION NO 265) (OPTIONAL)

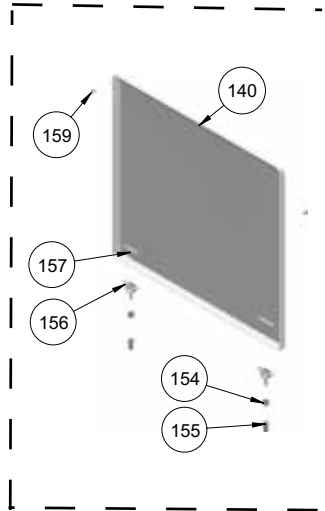

METAL LID OPTIONAL
(POSITION NO 153)

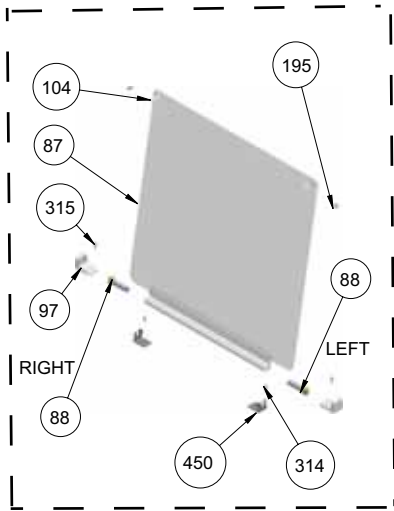

GLASS LID WITH BUMPER OPTIONAL

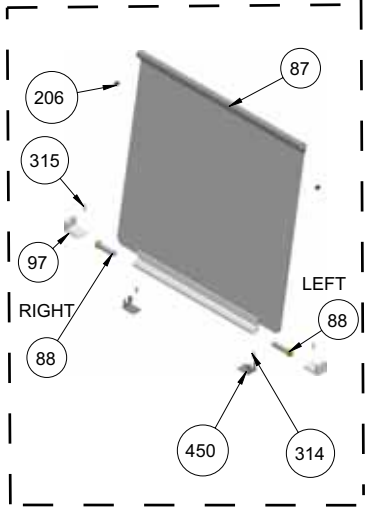

GLASS LID OPTIONAL

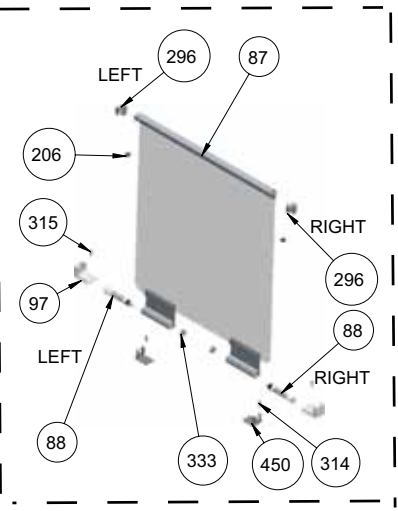

GLASS LID WITH SHORT PROFILE OPTIONAL

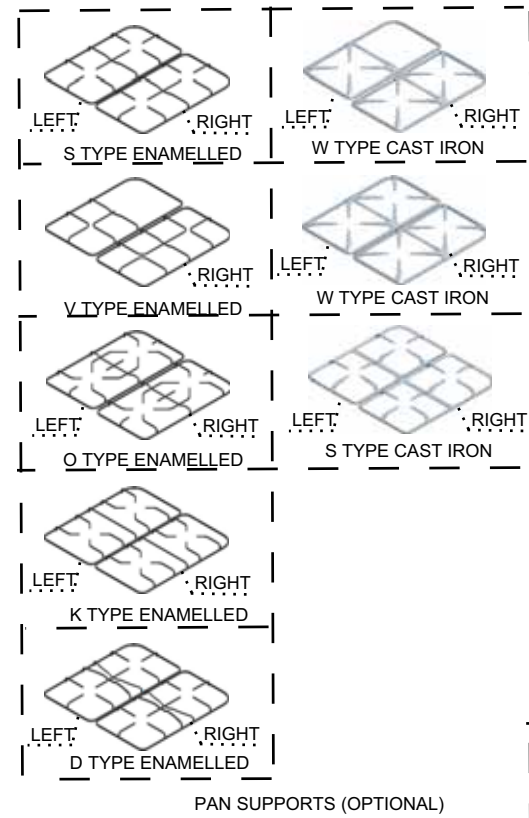

PAN SUPPORTS (OPTIONAL)

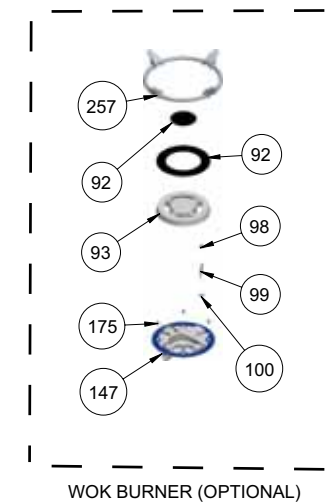

WOK BURNER (OPTIONAL)

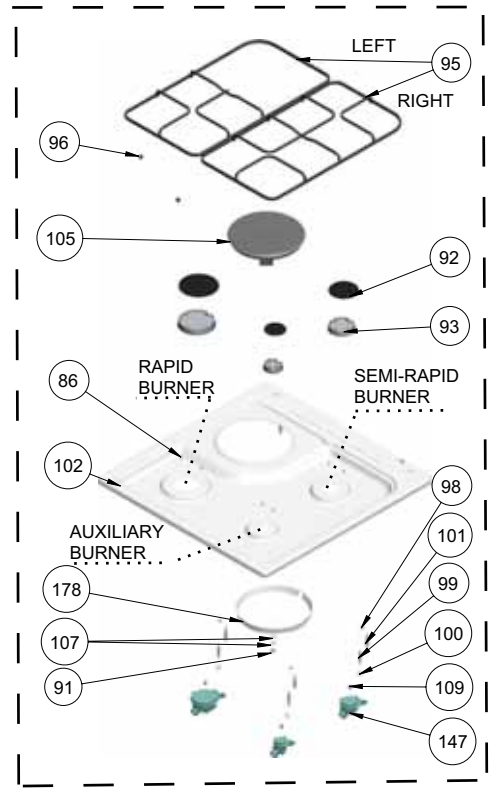
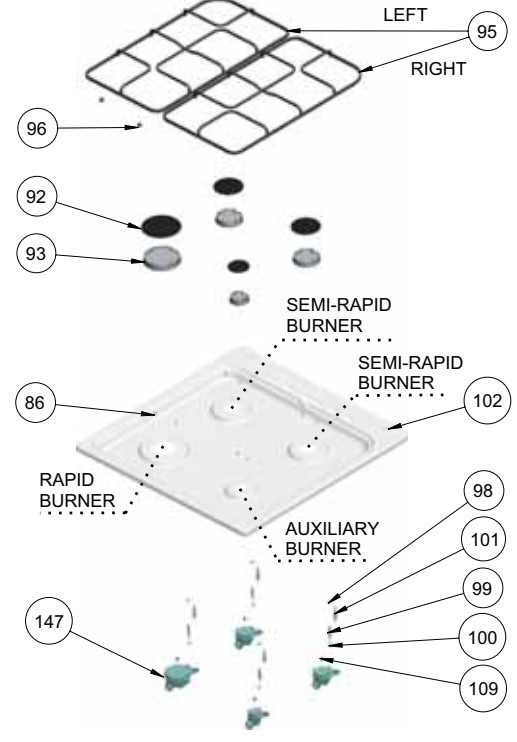

3 GAS 1 ELECTRIC

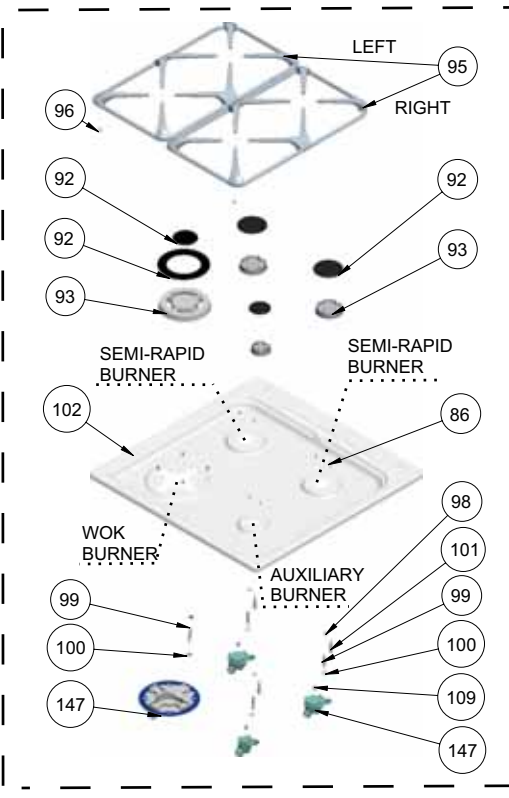

3 GAS + WOK BURNER

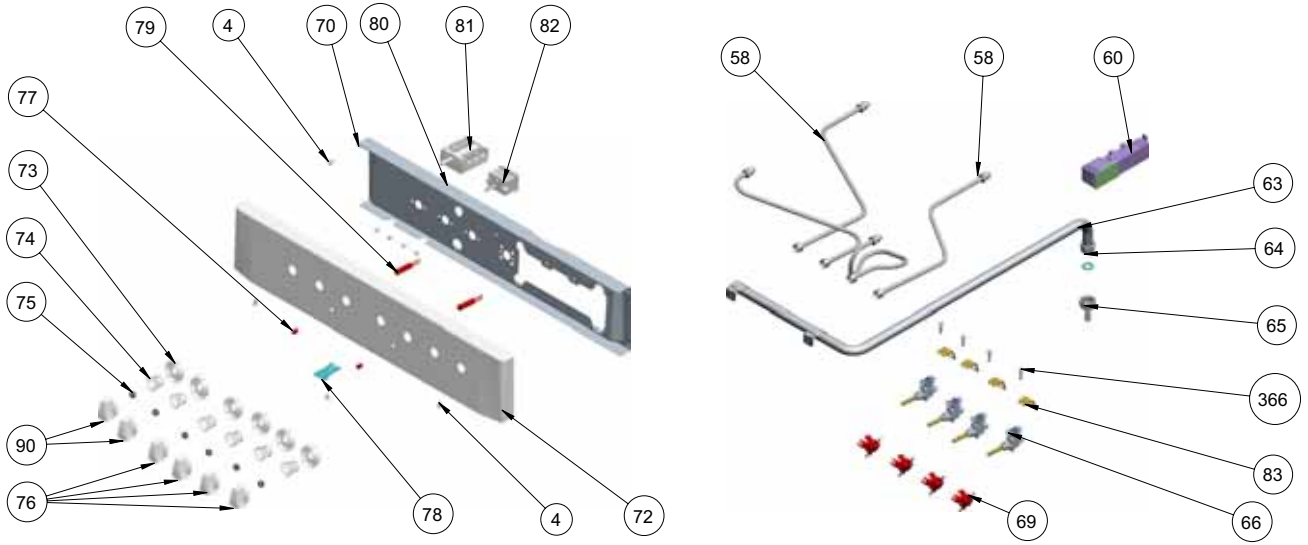

4GAS CONTROL PANEL ASSEMBLY

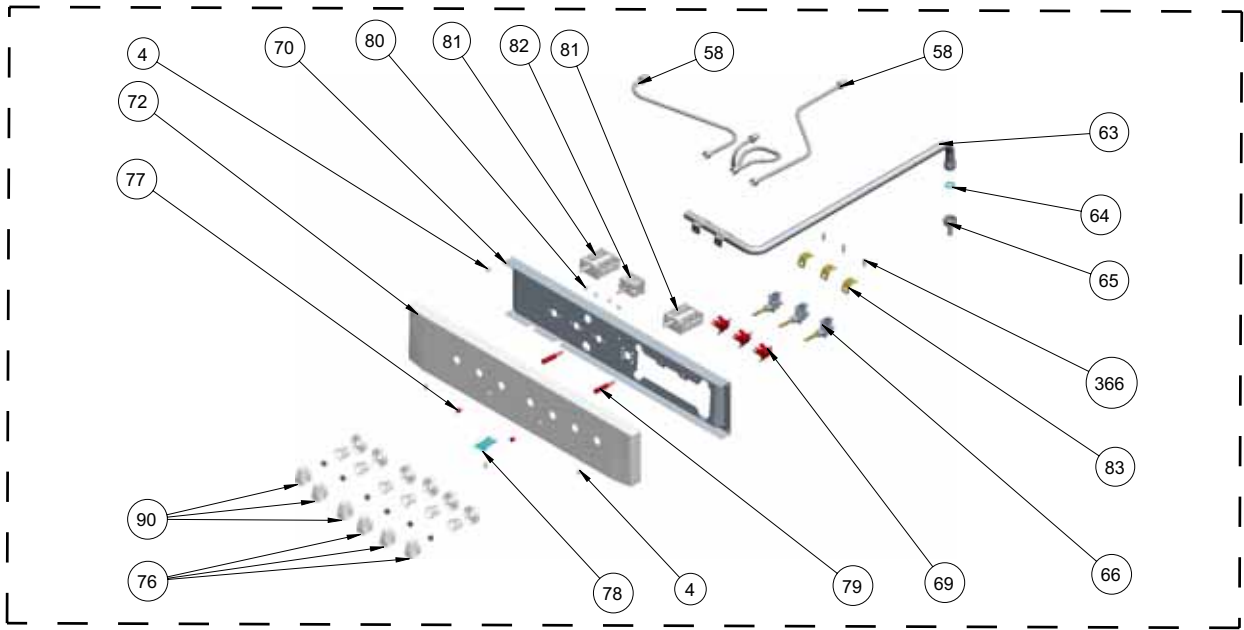

3G-1E CONTROL PANEL ASSEMBLY

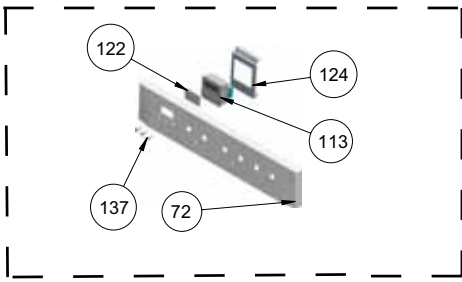

DIGITAL TIMER (OPTIONAL)

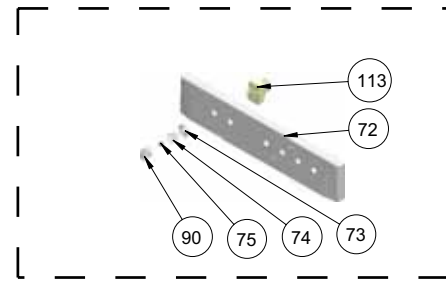

MECHANIC TIMER (OPTIONAL)

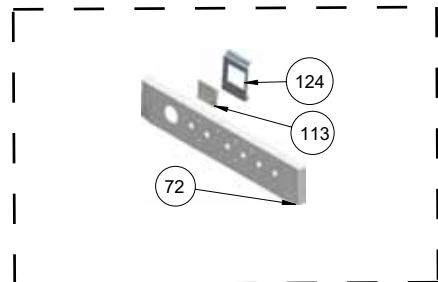

ANALOG TIMER (OPTIONAL)

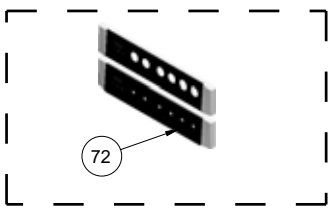

GLASS CONTROL PANELS (OPTIONAL)

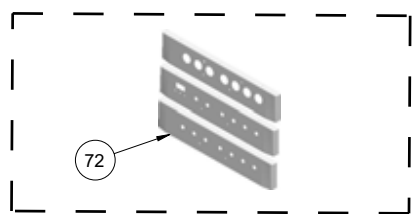

3D METAL CONTROL PANELS (OPTIONAL)

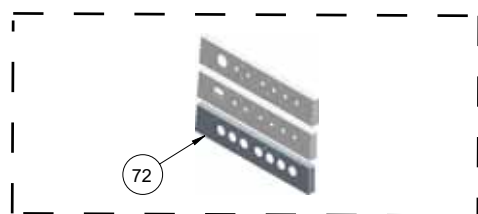

FLAT METAL CONTROL PANELS (OPTIONAL)

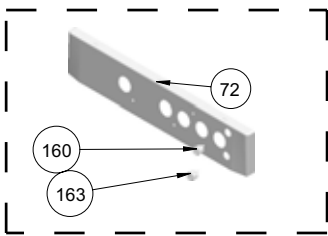

SPARK/LAMP BUTTON (OPTIONAL)



KNOBS (OPTIONAL)

EXPLODED VIEW - CONTROL PANEL ASSEMBLY

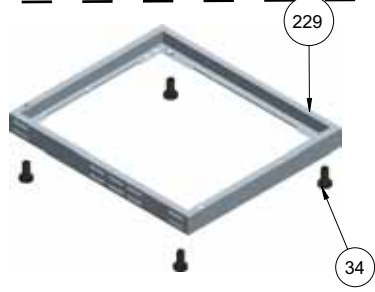

EXTRA BOTTOM SUPPORT (WITH LOUVRES)

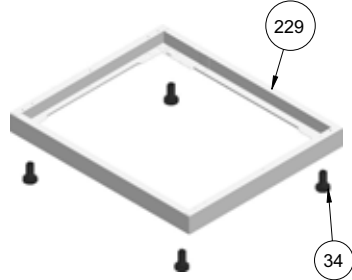

ADDITIONAL BOTTOM SUPPORT

OPTIONAL
(ONLY FOR FS 90 CM)

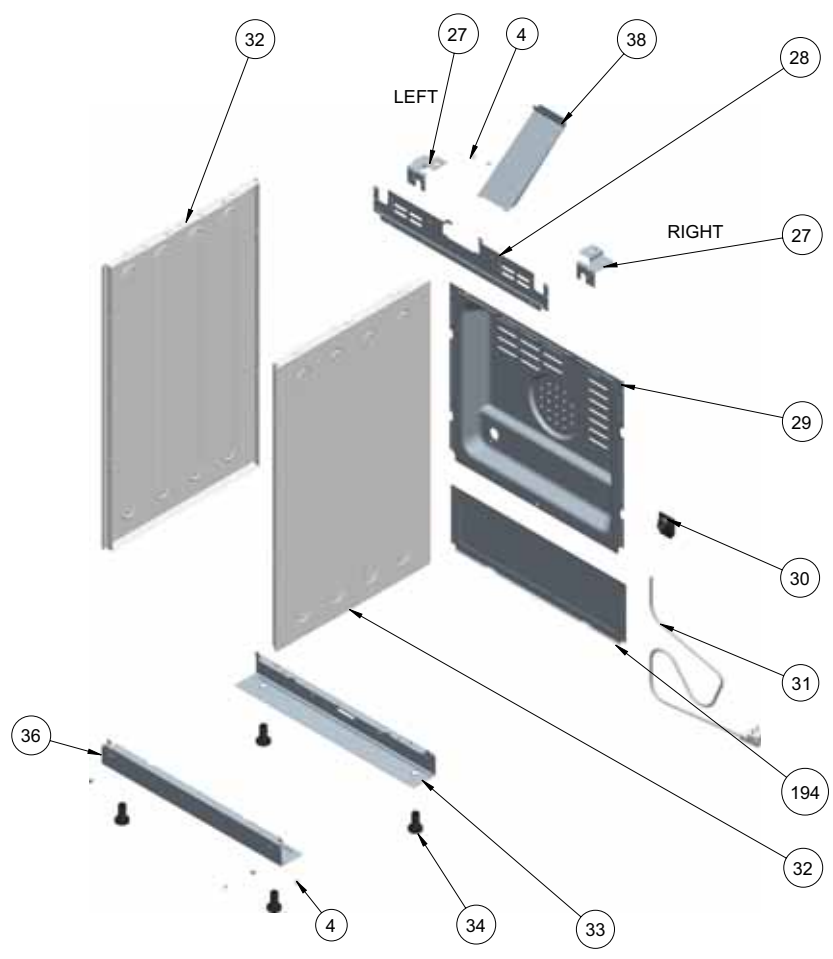

OVEN DOOR HANDLES (OPTIONAL)

HANDLES WITHOUT TAP & BRACKET

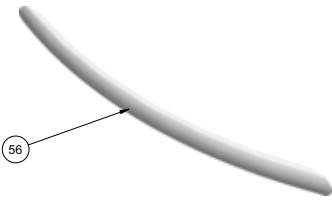

ELLIPSE ARC

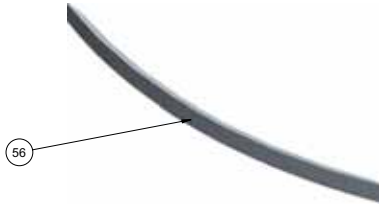

D PROFILE ARC

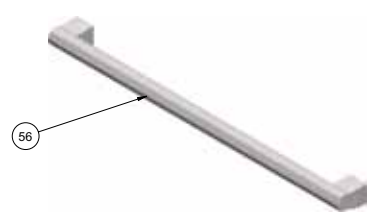

METALUX

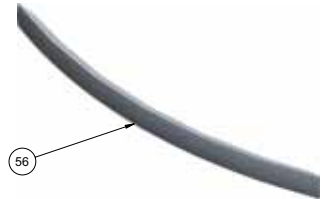

D PROFILE ARC, ELECTROLUX
(ONLY FOR FS - OPTIONAL)

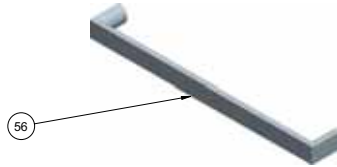

FNP
(ONLY FOR BUILT-IN - OPTIONAL)

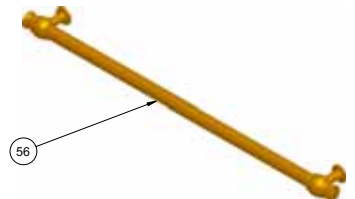

RUSTIC

HANDLES WITH BRACKET

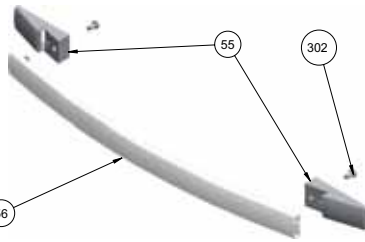

ARC QUADRANGLE

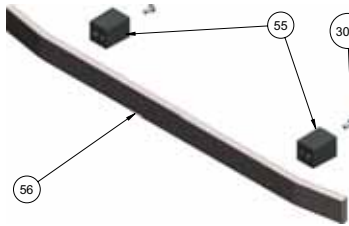

3D QUADRANGLE
(ONLY FOR FS/ NEW G/ BUILT-IN - OPTIONAL)

HANDLES WITH TUNNEL TAP

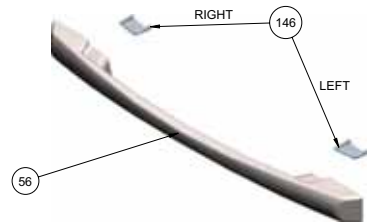

NO FAN TYPE
(ONLY FOR BUILT-IN - OPTIONAL)

HANDLES WITH TAP & BRACKET

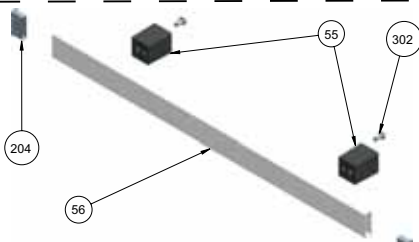

FLAT QUADRANGLE
(ONLY FOR FS/ NEW G/ BUILT-IN - OPTIONAL)

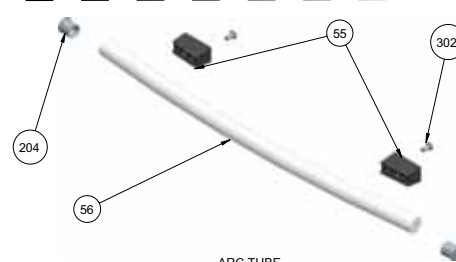

ARC TUBE

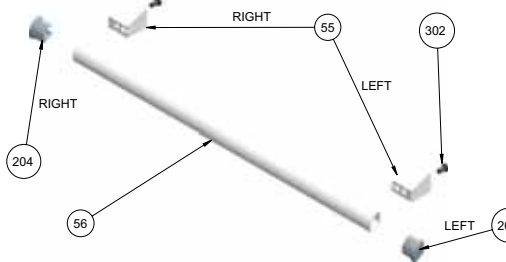

FLAT SLICE

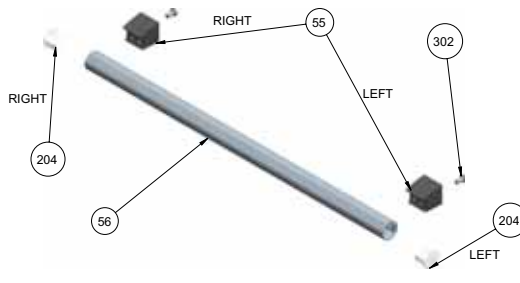

TRIO

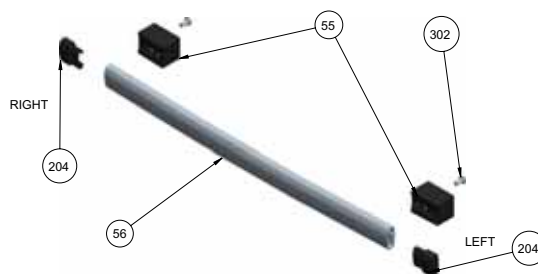

CURVED QUADRANGLE

KNOBS (ONLY FOR FS - OPTIONAL)

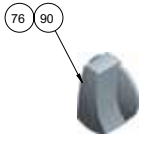

DELTA

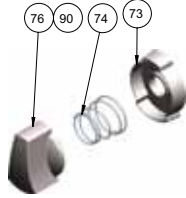

DELTA RING

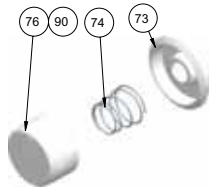

SIGMA (SMALL)

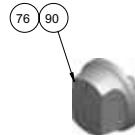

ALFA

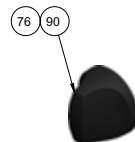

GAMA

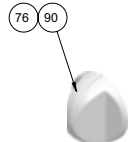

ZETA

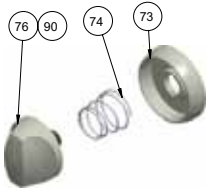

ELECTROLUX

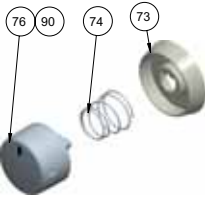

SIGMA KD

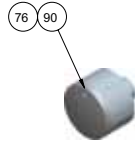

SMALL MACRO

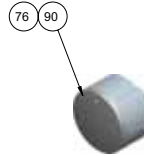

BIG MACRO

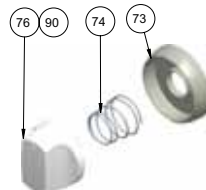

TRIO

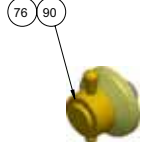

RUSTIC RISUS

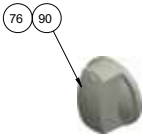

ECLIPSE

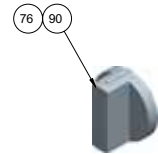

NORD



JANNU